

# DC Centrifugal Fans

Backward Curved,  $\Phi 220$

## DC后向离心风机



**Impeller:** Plastic PP  
**Motor:** DC brushless external rotor motor  
**Insulation:** Class B  
**Approvals:** CE;UL E306337  
**Operating Temperature:** -20~+60°C

叶轮材质: 塑胶PP  
 电机类型: DC无刷外转子电机  
 绝缘等级: Class B  
 产品符合的认证: CE;UL E306337  
 工作温度: -20~+60°C

### 技术参数 Specifications

Listed Model 产品型号	Rated Voltage 额定电压	Operating Voltage 工作电压	Rated Current 额定电流	Rated Power 额定功率	Rated Speed 额定转速	Air Flow 风量		Air Pressure 风压		Noise Level 噪音	Net Weight 重量
Part NO.	VDC	VDC	A	W	RPM	CFM	m <sup>3</sup> /h	mmH <sub>2</sub> O	inH <sub>2</sub> O	dBA	Kg
PI2422063HB2M	24	16~28	3.5	84.0	2,800	488.3	829.3	45.5	1.79	65	1.4
PI4822063HB2M	48	36~56	1.7	81.6	2,800	488.3	829.3	45.5	1.79	65	1.4

### 外形 Outline

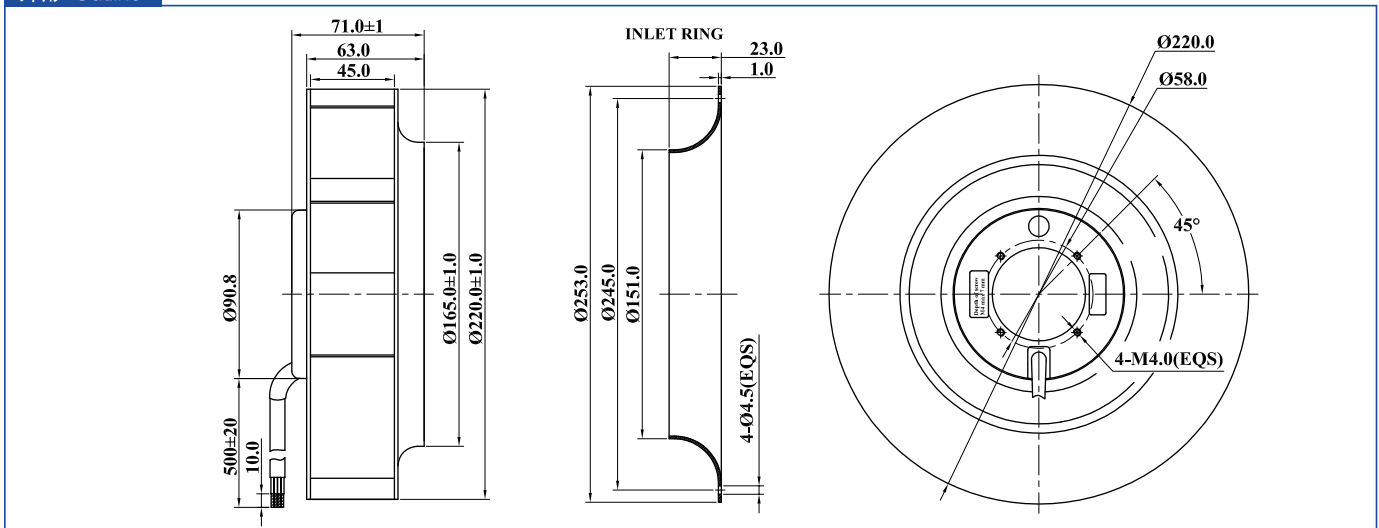

### 曲线 Curves

